

# Kinematics' not dead!

J-P. Merlet

INRIA Sophia Antipolis, France

E-mail: Jean-Pierre.Merlet@sophia.inria.fr

## Abstract

*A trend of thought in the robotics community is that kinematics most problems in kinematics have been solved and that this domain is slowly dying. The purpose of this paper is to show that there are still many unsolved problems in this field and that research on this topic may have a large influence in many different domains.*

## 1 Introduction

There is a trend in the robotics community that consider kinematics as a necessary but boring field that is slowly dying as the most interesting problems have been solved. This trend may be illustrated by what I will call the *nC* theory, for *cut the throat to kinematics, cut the cost of robots through sensors, computation and control* (in French all these words start with a "c"), which is popular in some part of the community. The idea is to produce cheaper robots by using rough mechanical components for the robot and correcting their defects by the use of a large number of sensors, sophisticated control laws and sheer computation power. This theory is based on the fact that sensors and computers are getting cheaper and cheaper, while the cost of high quality mechanical components is still high. I strongly disagree with this theory:

- the cost of the mechanical hardware does not exceed 20 to 30 % of a robotics system. Gaining a few % in this area will have only a marginal influence on the total cost
- if measuring the defaults of a faulty mechanical hardware may indeed be possible, but developing control laws to correct them will be a nightmare
- in my opinion computers power and control laws should be best used to develop an *intelligent behavior* of the robotics system at a whole without worrying about the low level task of controlling the basic motions of the robot

My theory is exactly the opposite: in many robotics application the mechanism of a robot may be seen as a *mechanical computer* with a processing power that may be surprisingly large. This mechanical computer should be in charge of the basic motions of the robot with only an occasional help of the *silicon computer* that may adapt the mechanism to make the best use of it and which, otherwise, will be used to control the intelligent behavior of the robotics system.

As an example consider a walking robot which will be in charge of walking in the corridors of a building to pick up outgoing mail and to put letters in the appropriate mailboxes. In the life time of the robot the walking mechanism will just produce a linear motion of the robot with a regular, periodic motion of the legs, making occasional right or left turn. On the other hand a lot of processing power is needed for performing efficiently the manipulation part of the tasks: for motion planning in an unstructured environment, picking up letters in a bin, dealing with stucked mailboxes etc. Now let us look at some of the existing walking machine that may be used for this task. They have sophisticated legs, each of them being almost controlled by a computer. At a higher level another computer is used to control each leg computer in order to produce the right gait motion. The few remaining on-board computer power is used to perform the intelligent part of the task. A direct consequence is that we get a slow walking machine which in addition is not very clever for picking up the letters. Now we can imagine another approach: we may design a leg mechanism with only one actuated joint that produce the correct leg displacement for a forward linear motion of the robot. By adjusting the phase of the motion of the legs we may produce the correct gait motion. We may even use only one motor to actuate all the legs (which will enable to modify at will the velocity of the robot). But we will have to change the direction of motion of the robot. This may be done by changing the *geometry* of the leg mechanism: actuators will change the lengths of some of the links of the mechanism so that the resulting displacement of the legs

will be appropriate for the new direction of motion. The on-board computation power will be used for the locomotion only in the transition phase to determine the leg mechanism geometry that has to be selected, to produce the right motion.

In this approach kinematics is a key-point with a fascinating synthesis problem. The purpose of the following sections is to illustrate on a few selected cases that open problems still exist in kinematics and that kinematics may still have a large influence in robotics and in other domains.

## 2 Direct kinematics of closed-loop chain

In this problem it is assumed that the geometry of the links and the position of the joints of the mechanism are known or measured and we have to determine the position and orientation of one particular rigid body of the mechanism. It has an application in different domains which may be seen in figure 1:

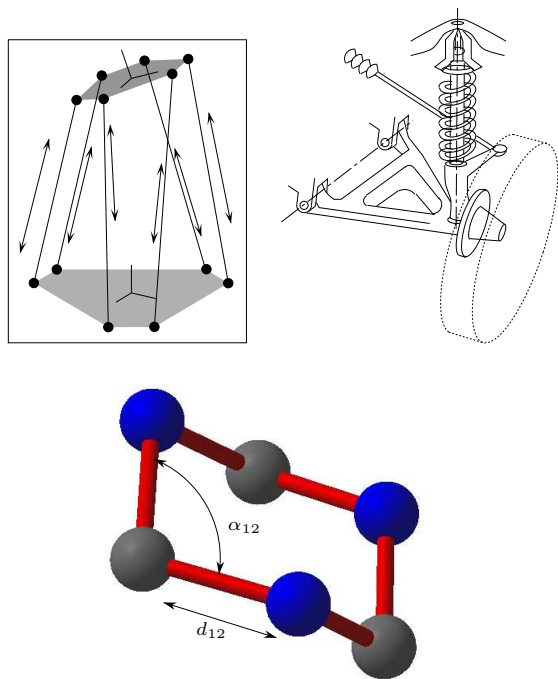

Figure 1: Some possible application of the direct kinematics: for a parallel robot, a suspension mechanism or a molecule

- for finding the pose of the end-effector of a Gough platform for fixed value of the lengths of the articulated legs

- for determining the pose of the wheel at a given altitude in an automotive suspension mechanism
- for calculating the possible shapes of a molecule being given the distance between adjacent pair of atoms or the angle in a triplet of atoms

The approach to solve this problem is to write the distance equations which lead to a system of equations. This system may first be analyzed to determine a bound on its maximal number of solution (for example Ronga shows that the direct kinematics of the Gough platform admits up to 40 solutions [11]). Then we manipulate the equations to reduce the system to the solution of an univariate polynomial whose degree should be at most the one which has been obtained in the analysis. Note that this approach requires an extensive use of symbolic computation tools. Usually the resulting polynomial will have a degree such that it does not admit an analytical form for its solutions (40 for the Gough platform as computed by Husty [6]) which prohibits its use in a real-time context. This has led authors to claim that there was no closed-form solution for the direct kinematics. As the coefficients of the polynomial have a very large analytical form it is not possible to test whether this polynomial may have a reduced analytical expression. For example for the Stewart platform the analysis shows that there may be at most 12 solutions. By manipulating the distance equations it is indeed possible to obtain a 12th order univariate polynomial. But a more thorough analysis based on a geometrical approach has enabled to show that this polynomial was in fact the product of two 6th order polynomials [10]. Outside factorization, another possible simplification may be that the polynomial is the result of the composition of two or more polynomials.

Remember also that determining all the solutions of the direct kinematics may be only a first step in the analysis as for a physical system we may be interested only in the current pose of the rigid body: hence we may have to sort all the solutions.

## 3 Kinematics and algebraic geometry

The previous section is a good illustration of the close relationship between kinematics and algebraic geometry. This is a long-lasting relation and in the eighteenth century the study of kinematics was compulsory for any decent mathematician. To illustrate it let us remind two fascinating theorems. The first one is due to Freudenstein [5]: he shows that for a planar 1 DoF mechanism with only revolute joints any

point on a link follows an algebraic curve. The second theorem is due to Kempe [9] and is somewhat the reciprocal to Freudenstein's: being given an arbitrary algebraic curve in 2 unknowns, it is always possible to design a 1 DoF mechanism such a particular point of the mechanism will follow, at least partially, the algebraic curve. The interesting point in Kempe's theorem is that is constructive: he shows how to construct the mechanism by combining addition, multiplication, etc.. mechanisms. This long-standing relationship between kinematics and algebraic geometry is still continuing in the modern era: mathematicians are eager to study kinematics problems to test their algorithms and even develop new specific one. For example one of the fastest algorithm ever proposed to solve the direct kinematics of parallel robots is a combination of the Gröbner basis software FGB of Faugère [4] and the fast real roots solver RS from Rouillier [12]. It is quite unfortunate that the impressive progress in algebraic geometry, which have benefited from the study of kinematics, remain largely ignored in the robotics community.

## 4 Strange mechanisms

Kinematics has helped to discover new strange mechanisms with surprising behavior. Let us begin with *modular robots*: the basic idea here is to propose robots whose geometry may be adjusted to adapt the performances of robots to the tasks they have to perform. There has been some trial in this matter for serial robots, but in that case the mechanisms which are used to change the geometry become a component of the moving part of the robot, thereby increasing its mass and reducing the performances. But closed-chain robots are more adapted for modular robots: by just changing the locations of the joints attached to the base (which are not moving with the robot) we may completely modify the behavior of the robot without any loss in the dynamic performances [13]. An open problem is to determine what is the best geometry for a particular task, i.e. to be able to compute efficiently the main performances of a robot with a particular geometry.

Another strange mechanism is the *binary robot*. Imagine a Gough platform whose actuators have a binary behavior: they may be only fully extended or fully retracted. There is therefore 64 different possible actuator configurations and, at least, 64 corresponding possible end-effector poses. Now you stack 4 such modules on top of each other. The final upper platform may reach up to  $64^4 = 16777216$  poses!. The

control of such manipulator is quite easy (you may use directly the parallel port of a PC), with an easy maintenance and its cost will be low. However you will get a very fast robot which may be quite appropriate for fast pick-and-place operations. The kinematics problem here is to design the modules to get a dense workspace (see figure 2 for an example of workspace density) and a good motion planner to use at best the possibility of the robot [3].

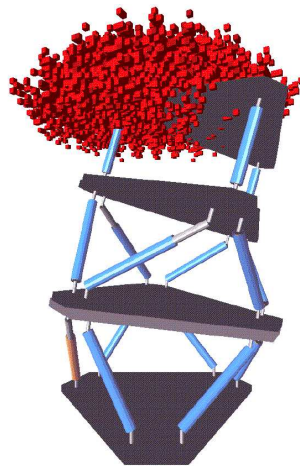

Figure 2: An example of workspace density for a binary robot

Let us consider again closed-loop mechanisms. They exhibit singular configurations which may be quite dangerous as in these poses the articular forces may go to infinity causing a breakdown of the mechanism. In a singularity there will be an infinitesimal motion of the end-effector for locked actuators. Usually singularities are either isolated or describe a surface: the infinitesimal motion of the end-effector will thus move the end-effector away from a singularity. But for some particular geometries the mechanism may be always in a singularity with finite articular forces [2]. Thus we may design 1 DoF mechanism like a *permanently singular Gough platform* [7]. What is interesting is the corresponding motion of the robot: it may be an helix whose pitch is a simple function of the geometry of the robot. Now imagine that you add an actuated leg to the robot: by controlling this single actuator you will be able to control the motion of the end-effector on the helix. You may imagine that this is a fascinating perspective for manufacturing ship screws.

Another interesting possibility, still for closed-loop mechanism, is to use *wires* instead of rigid link for building robots. Classical motors are substituted by

winchers that will increase or decrease the lengths of the wire, enabling to control the pose of the end-effector. Such robot may be used as crane (like in the ROBOCRANE project [1]) or for designing very fast robot (like the FALCON robot [8], figure 3). We

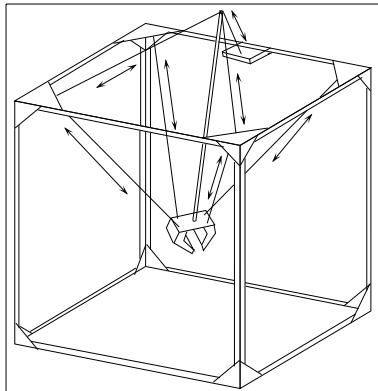

Figure 3: The FALCON wire robot

have here also interesting kinematics problems: for example the determination of the workspace of the robot should take into account not only the minimal and maximal length of the wires but also that tension should be kept into the wires.

## 5 Micro-machines

Some mechanical architectures are scalable almost at will. Thus we may design a micro Gough platform (figure 4) or micro steam machine (figure 5). Here

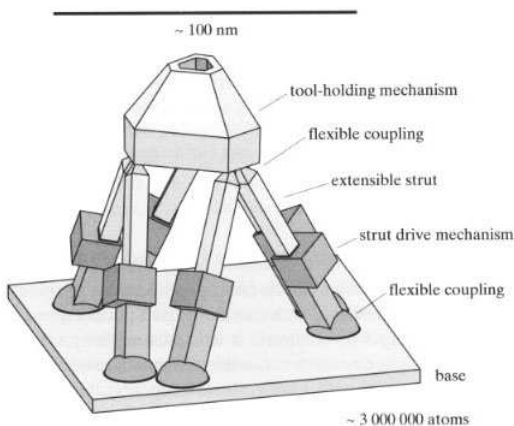

Figure 4: Micro Gough platform

kinematics has to deal mostly with design problems. At this size scale atomic forces become preponderant

and play a large role on the efficiency of the mechanism. Kinematics design has to take into account these forces for getting a working mechanism.

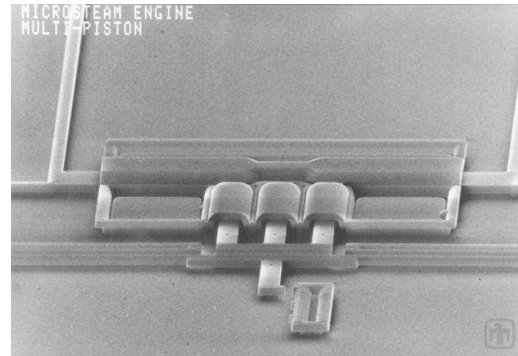

Figure 5: Micro steam machine

## 6 Medical applications

Kinematics may also still play an important role in medical applications. For example we still don't fully understand how is working the knee joint (figure 6), although it will be necessary to implement efficiently artificial ligaments. At the same time the emergence

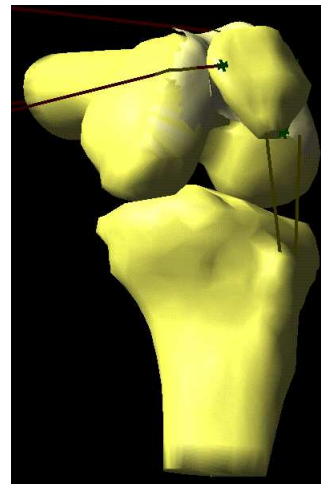

Figure 6: The knee joint

of the *minimally invasive surgery* may motivate the study of accurate and safe medical robots (like the one proposed by the Fraunhofer Institute of Stuttgart,

figure 7), in which kinematics will play an important.

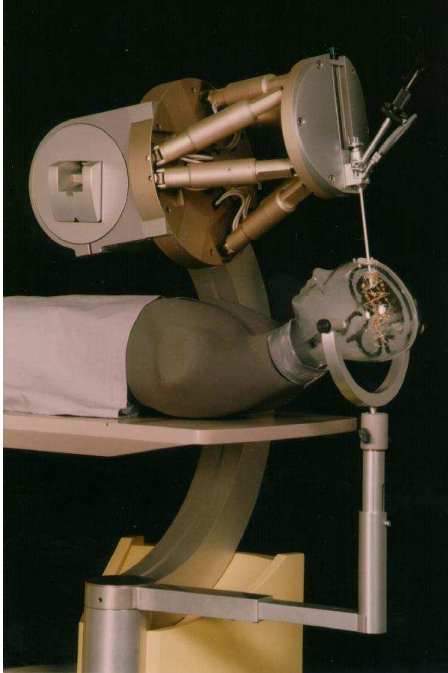

Figure 7: A neuro-surgical robot developed by the Fraunhofer Institute of Stuttgart

## References

- [1] Albus J., Bostelman R., and Dagalakis N. The NIST ROBOCRANE. *J. of Robotic Systems*, 10(5):709–724, July 1993.
- [2] Bricard R. Mémoire sur les déplacements à trajectoire sphériques. *Journal de l'École Polytechnique*, 11(2):1–96, 1906.
- [3] Chirikjian G.S. A binary paradigm for robotic manipulators. In *IEEE Int. Conf. on Robotics and Automation*, pages 3063–3070, San Diego, May, 8-13, 1994.
- [4] Faugère J.C. and Lazard D. The combinatorial classes of parallel manipulators. *Mechanism and Machine Theory*, 30(6):765–776, August 1995.
- [5] Freudenstein F. On the variety of motion generated by mechanisms. *Transaction of the ASME*, pages 156–160, February, , 1962.
- [6] Husty M.L. An algorithm for solving the direct kinematic of Stewart-Gough-type platforms. Research Report TR-CIM-94-7, Université McGill, Montréal, June, 30, 1994.
- [7] Karger A. and Husty M. Classification of all self-motion of the original Stewart-Gough platform. *Computer-aided design*, 30(3):205–215, 1998.
- [8] Kawamura S. and others . Development of an ultrahigh speed robot FALCON using wire drive system. In *IEEE Int. Conf. on Robotics and Automation*, pages 215–220, Nagoya, May, 25-27, 1995.
- [9] Kempe A.B. On a general method of describing planes curves of the nth degree by linkwork. *Proc. of the London Mathematical Society*, 7:213–216, 1876.
- [10] Lazard D. and Merlet J-P. The (true) Stewart platform has 12 configurations. In *IEEE Int. Conf. on Robotics and Automation*, pages 2160–2165, San Diego, May, 8-13, 1994.
- [11] Ronga F. and Vust T. Stewart platforms without computer?, 1992. Preprint.
- [12] Rouillier F. Real roots counting for some robotics problems. In J-P. Merlet B. Ravani, editor, *Computational Kinematics*, pages 73–82. Kluwer, 1995.
- [13] Yang G., Chen I-M., and Yeo S.H. Design consideration and kinematic modeling for modular reconfigurable parallel robots. In *10th World Congress on the Theory of Machines and Mechanisms*, pages 1079–1084, Oulu, June, 20-24, 1999.