

Information propagation in social networks

Maksym Gabielkov, Ashwin Rao, Arnaud Legout

EPI DIANA, Sophia Antipolis

{maksym.gabielkov, arnaud.legout}@inria.fr

Friends





Producer
Consumers

TF1

Follow Relationship in Twitter

Bob follows Alice
Alice follows Bob

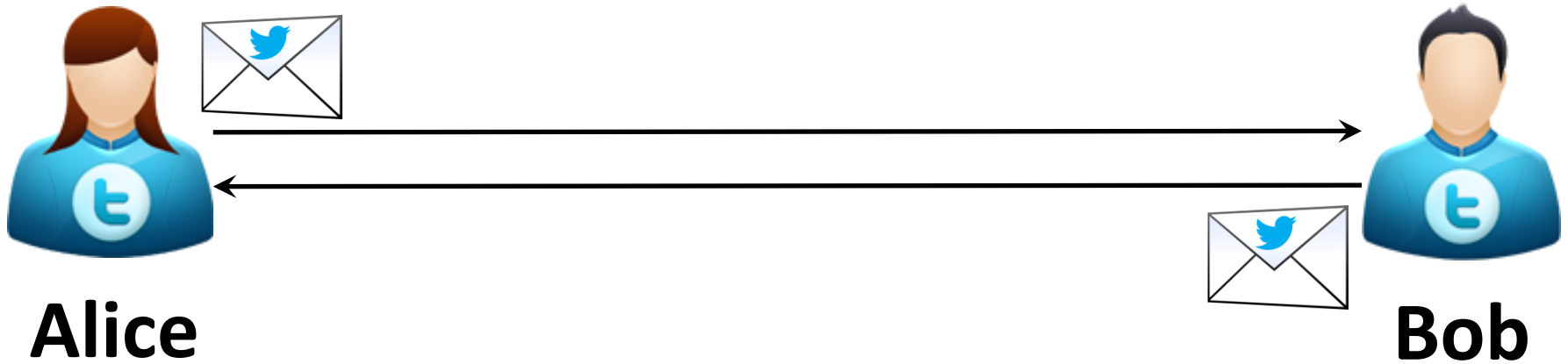

The Twitter Social Graph

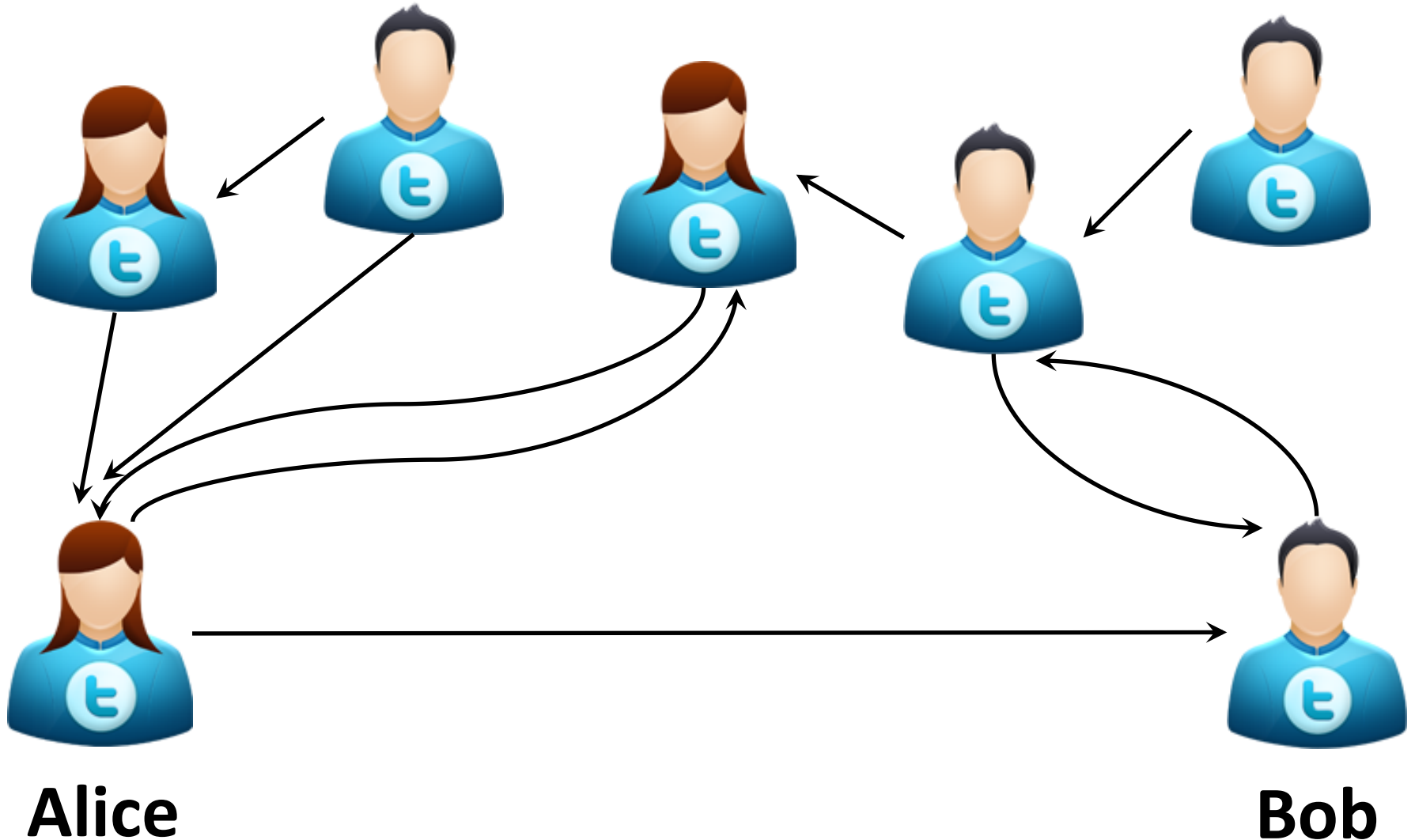

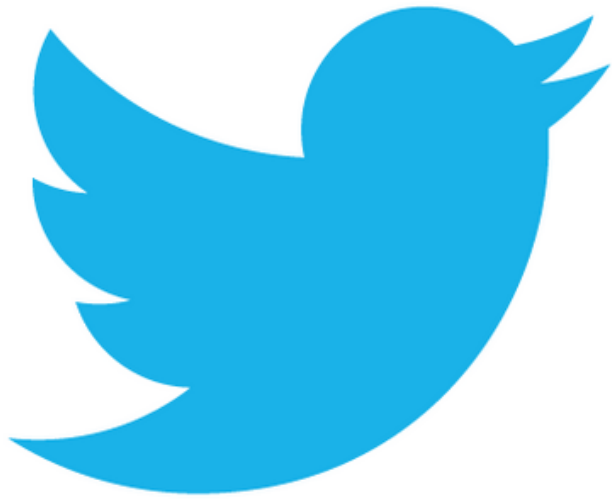

+500 million nodes
+24 billion edges

Challenges

1. Collect the graph
2. Decompose the graph
3. Give a physical meaning to the decomposition

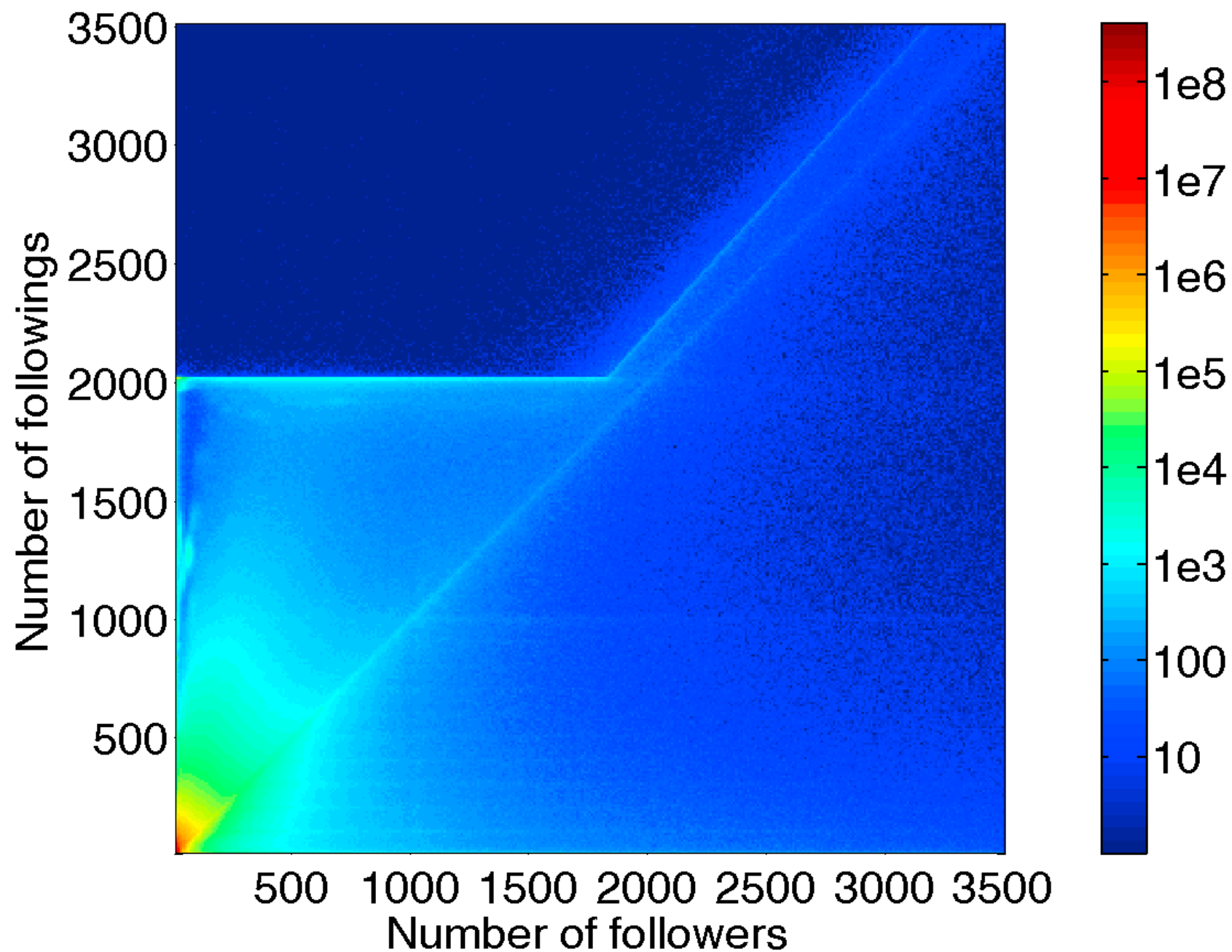

How is constraint
information propagation?

Identify the highways

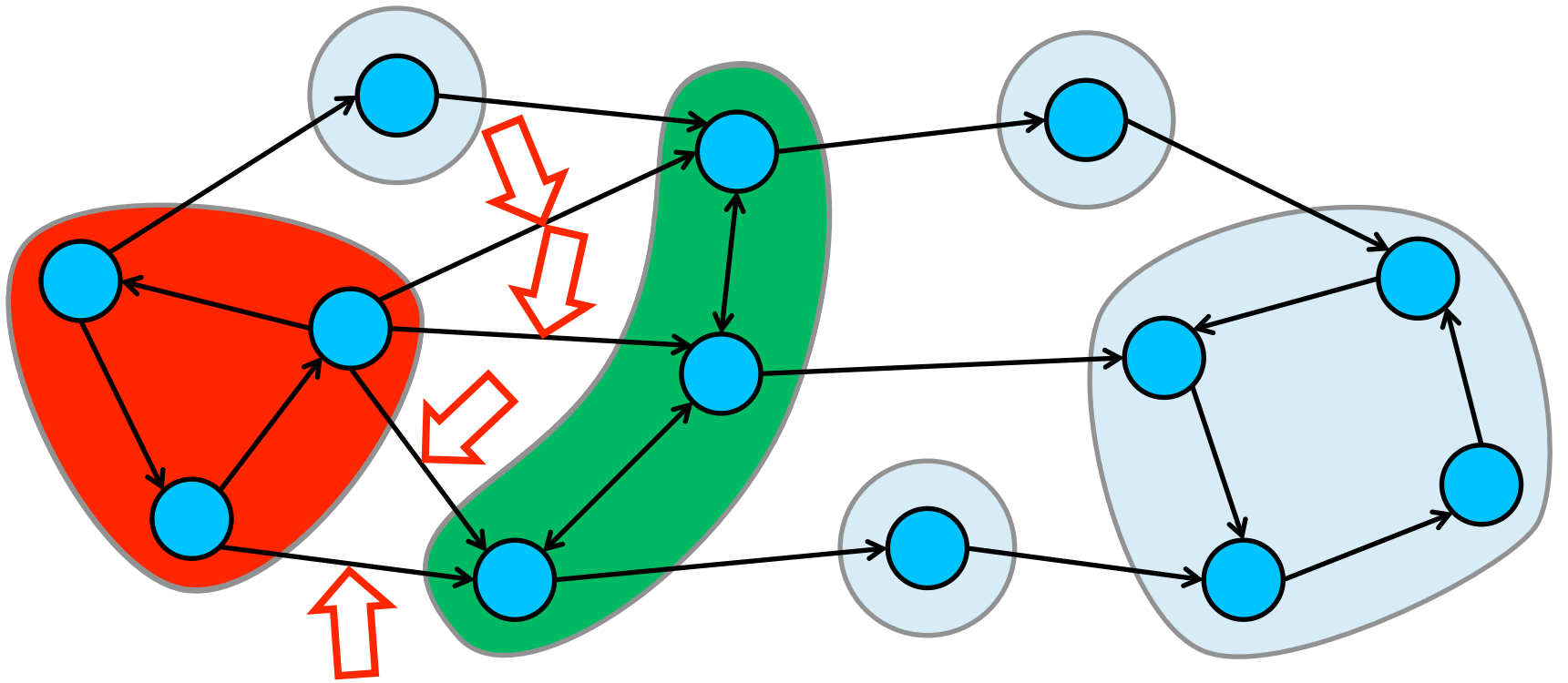

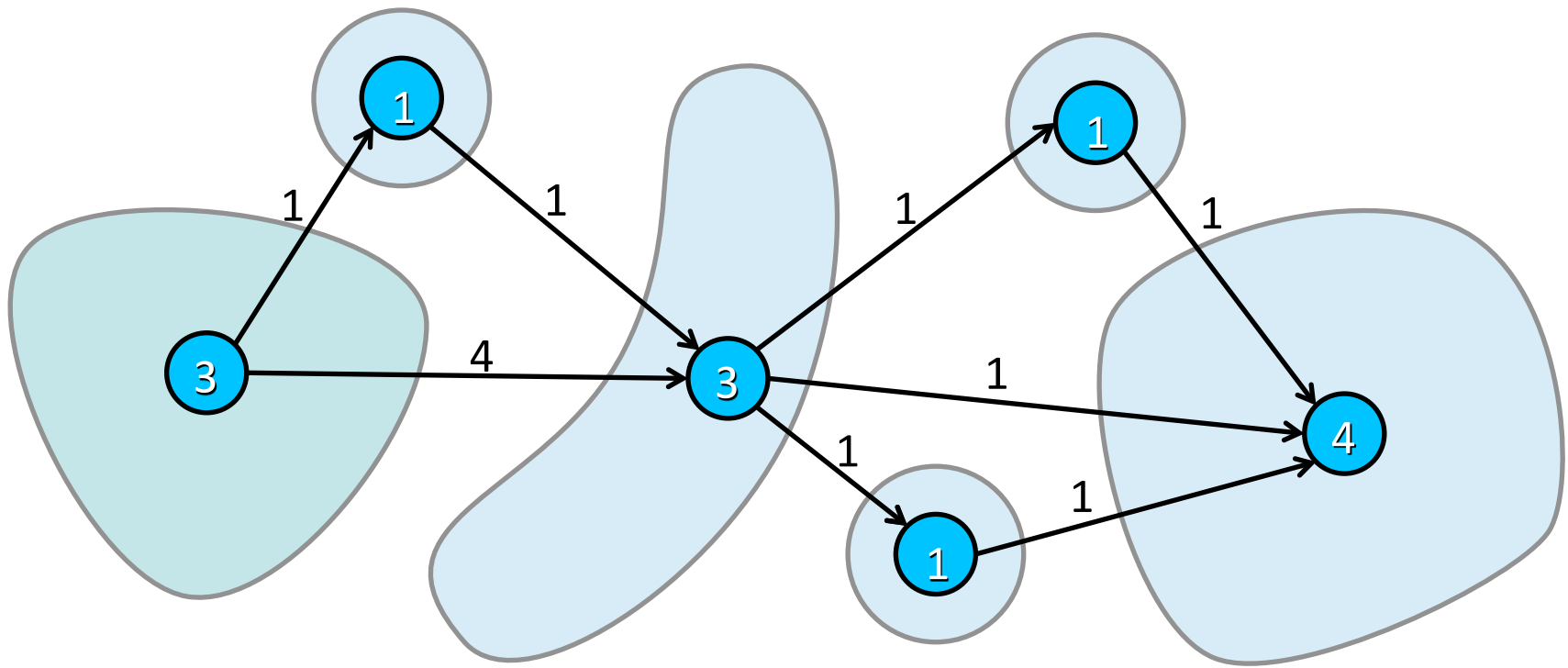

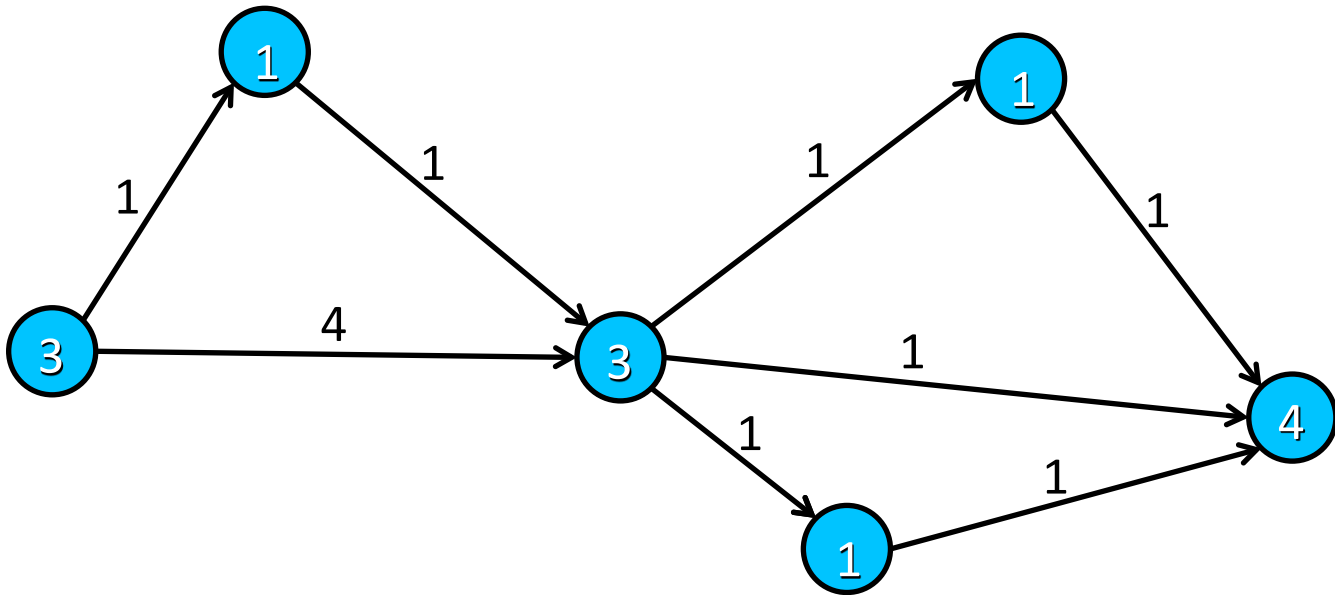

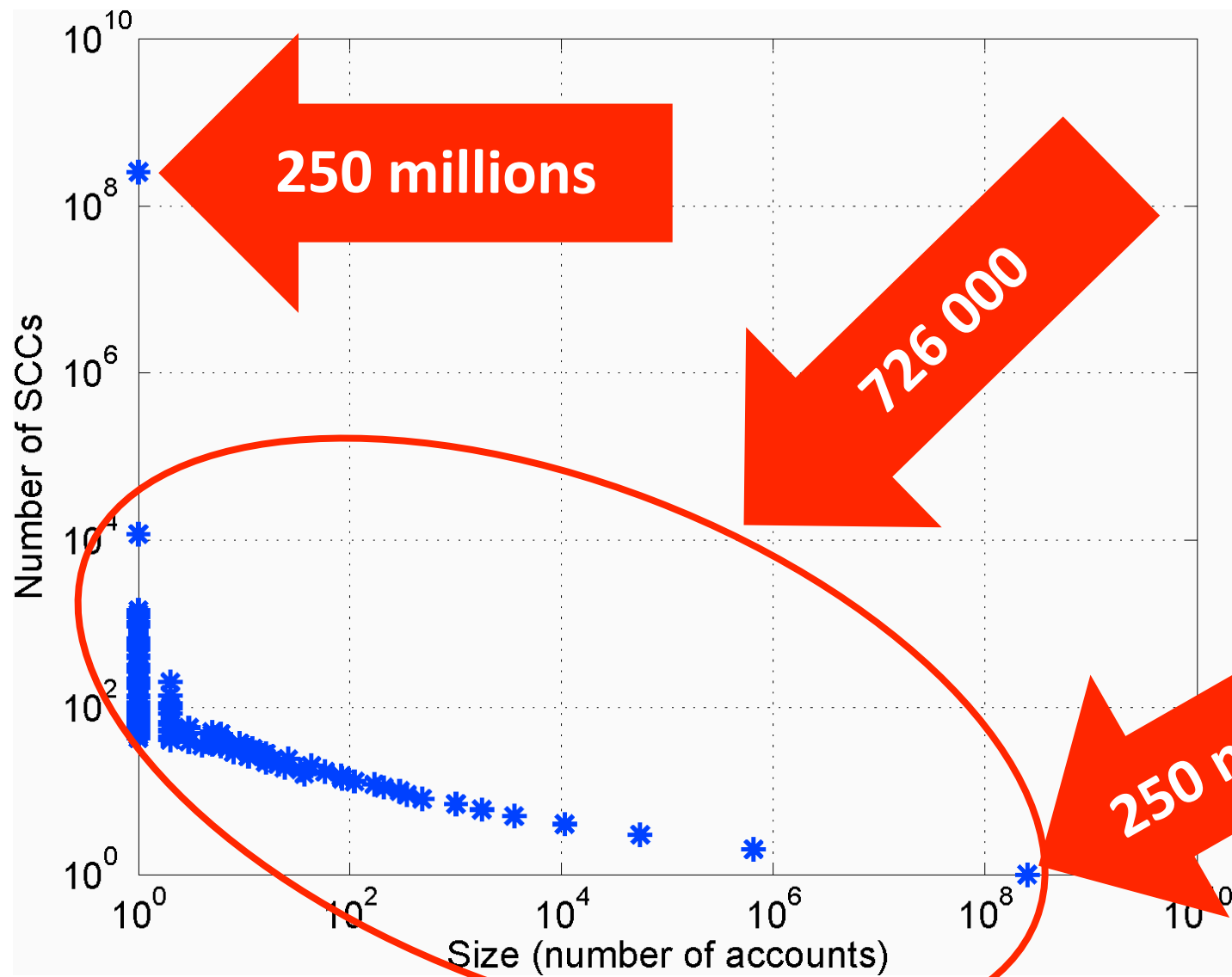

Twitter social
graph

500 million nodes

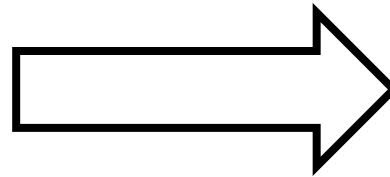

Directed
acyclic graph

249 million nodes

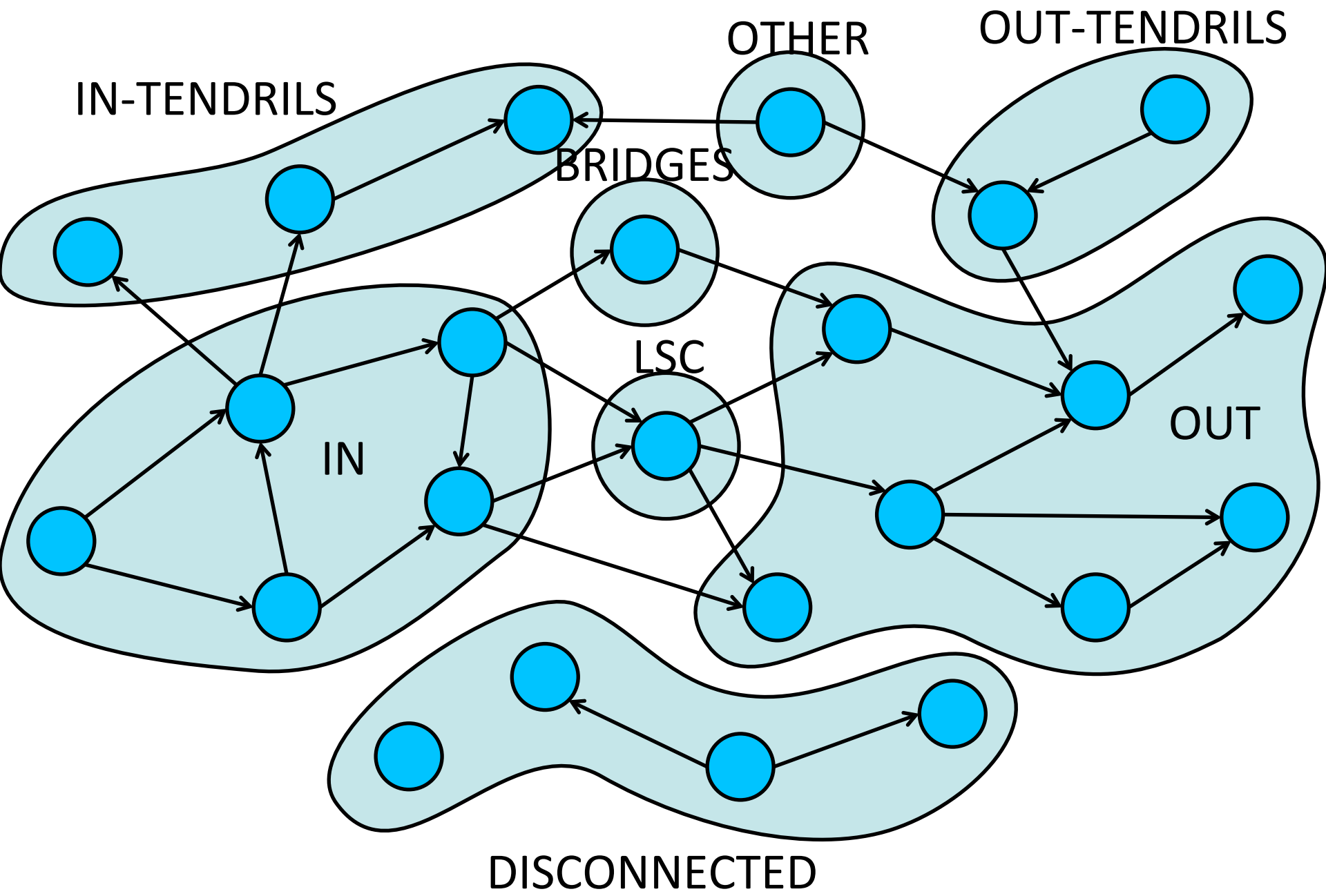

Twitter social
graph

500 million nodes

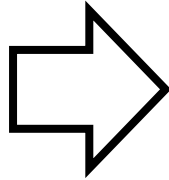

Directed
acyclic graph

249 million
nodes

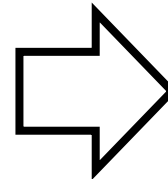

Macro
structure

8 components

What is the physical
meaning of decomposition?

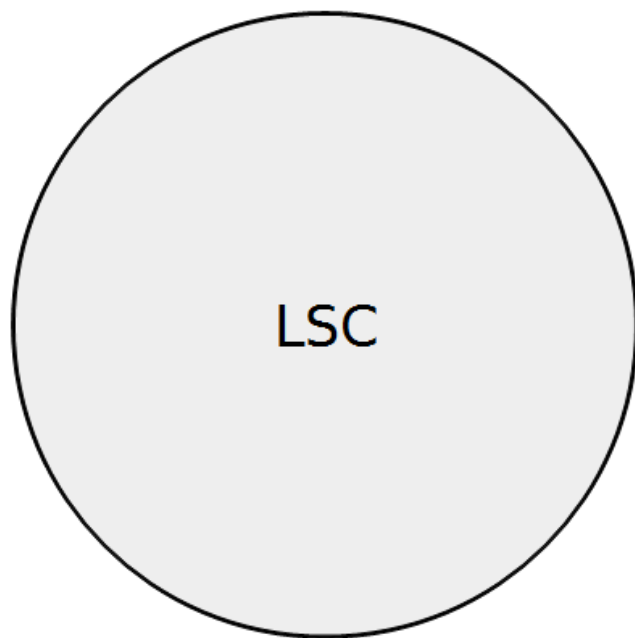

LSC

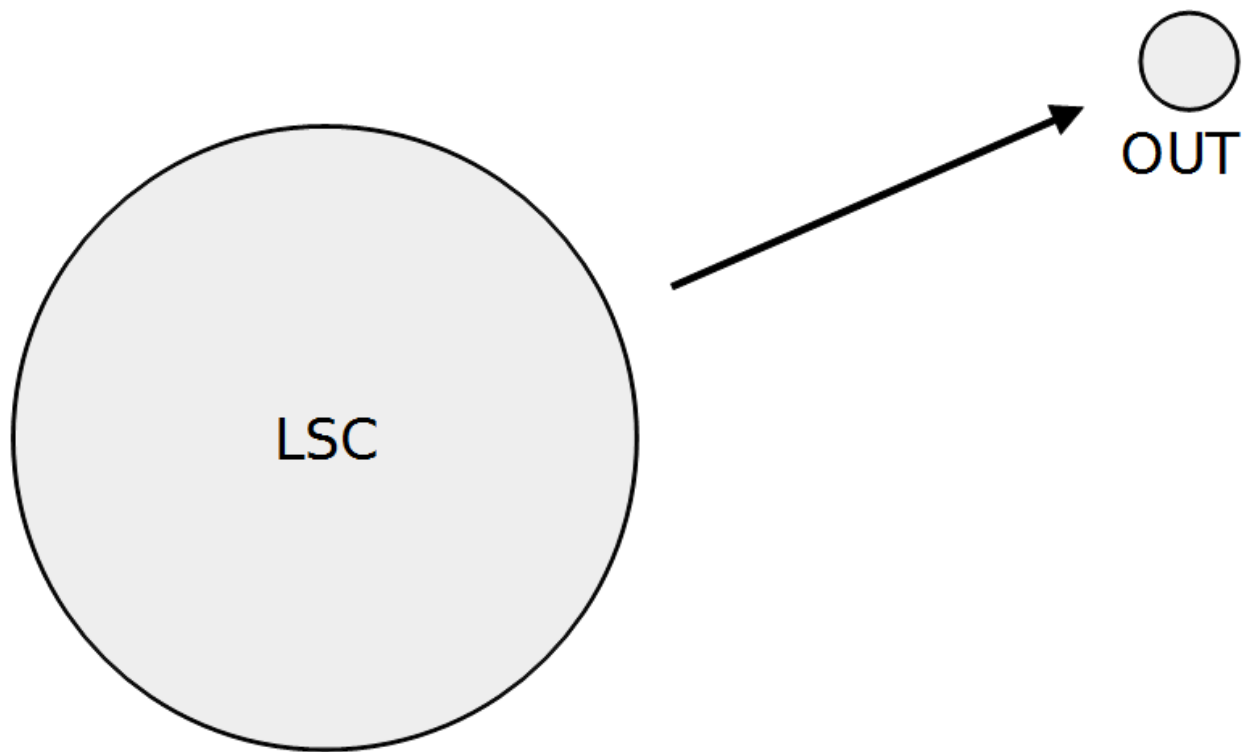

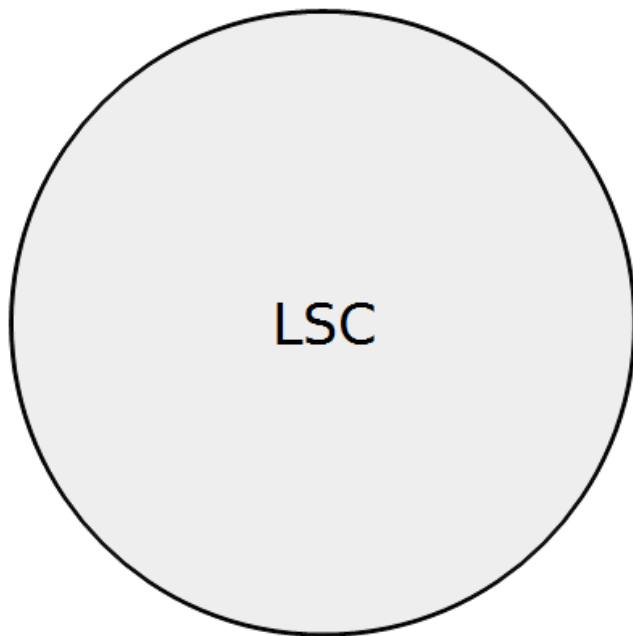
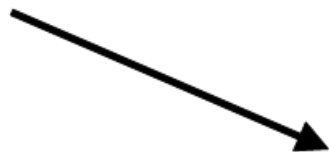
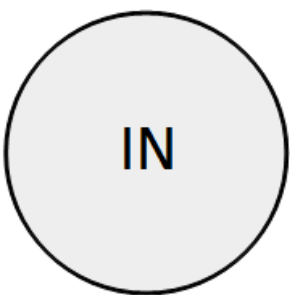

OUT

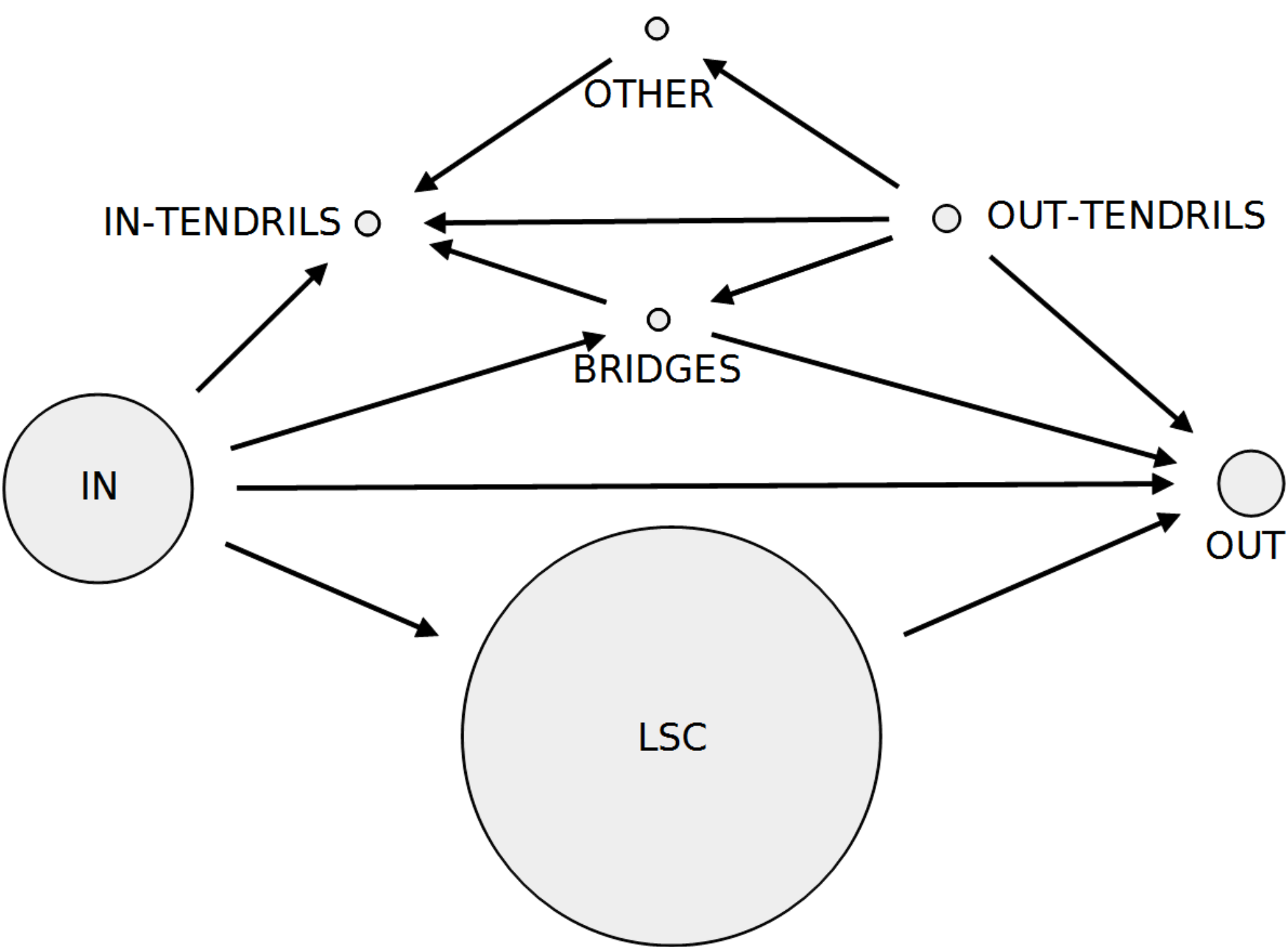

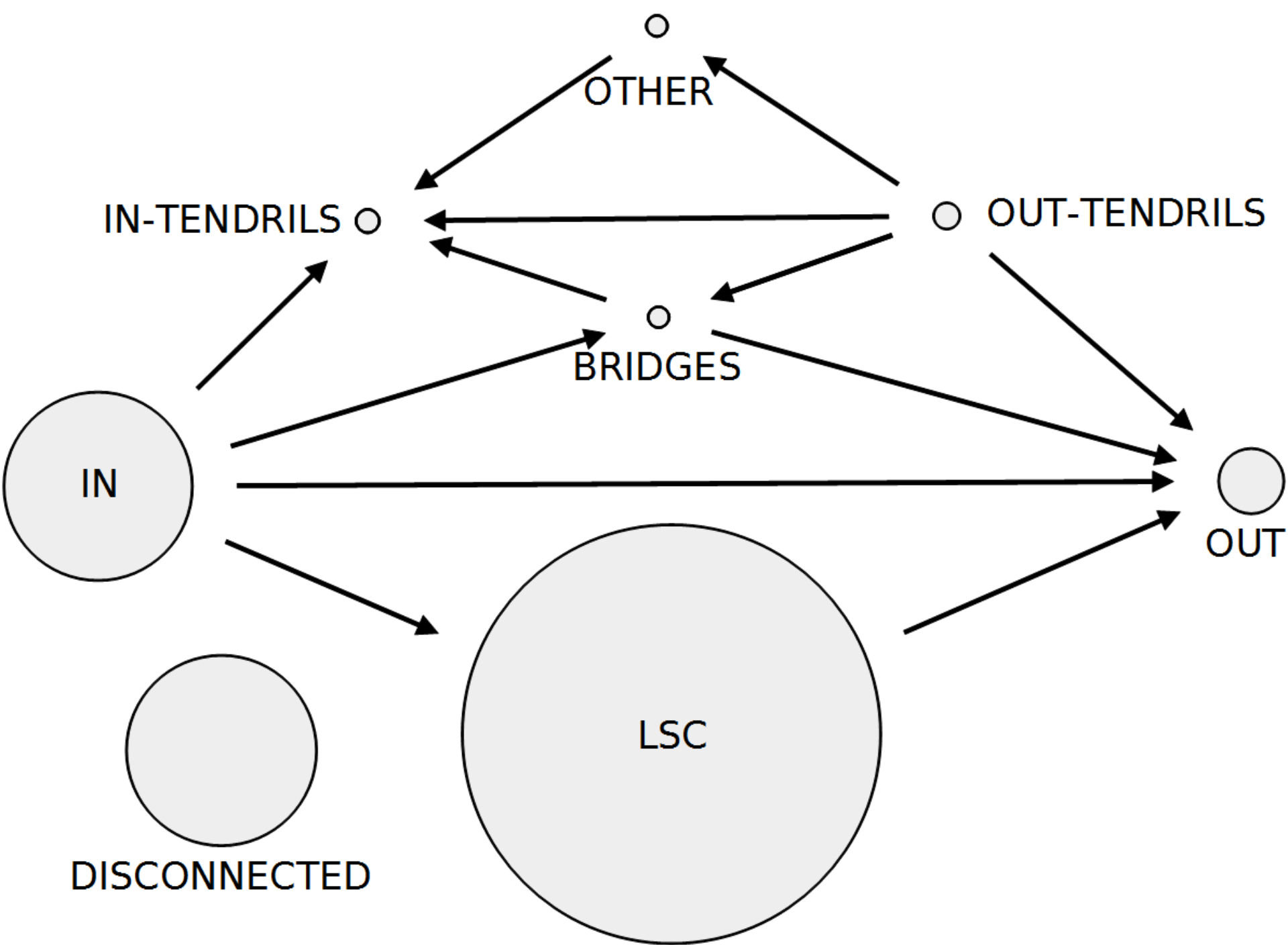

1% accounts

<0.01% edges

<0.01% tweets

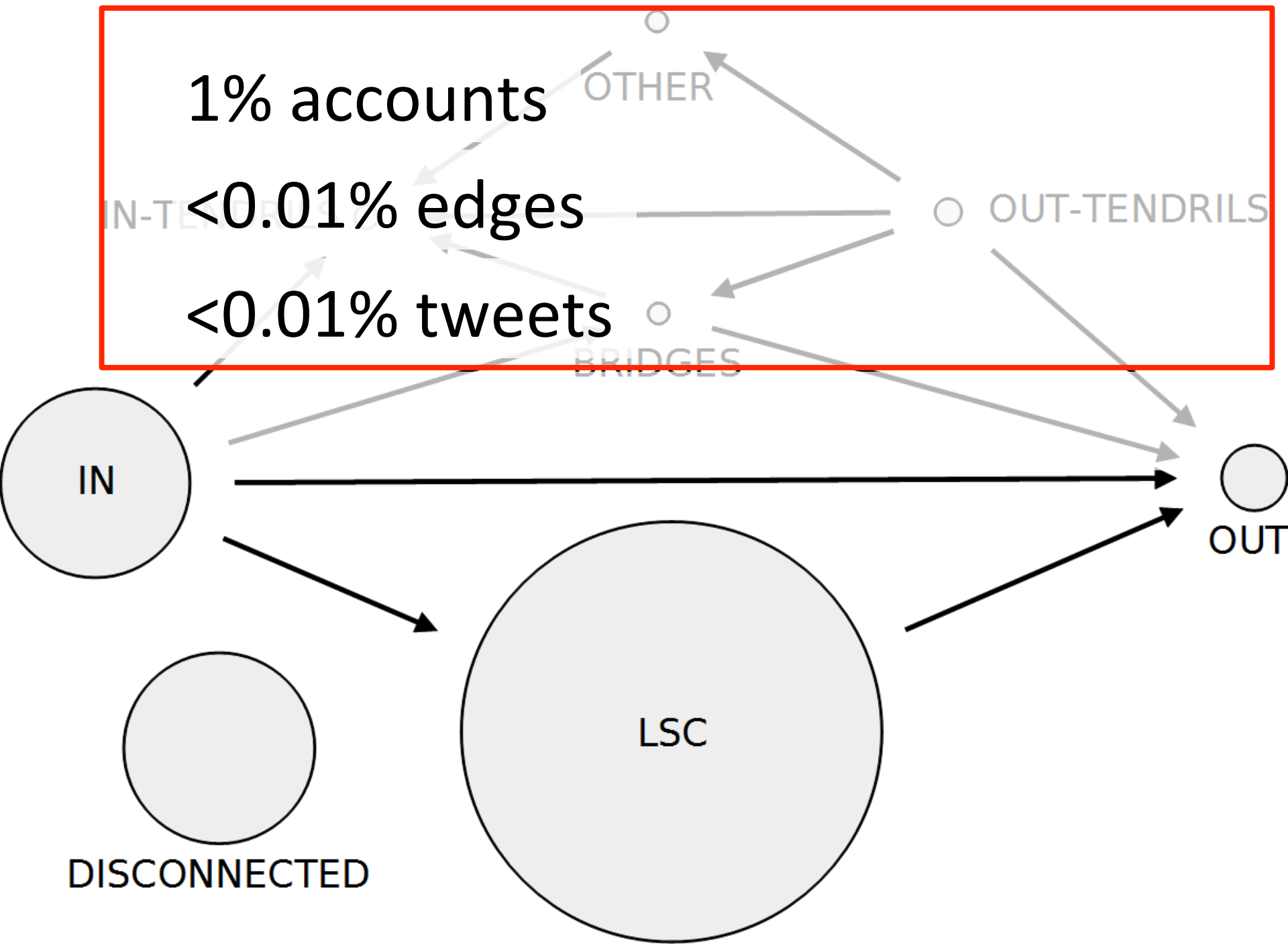

98% of the tweets
98% of the edges
50% of the accounts

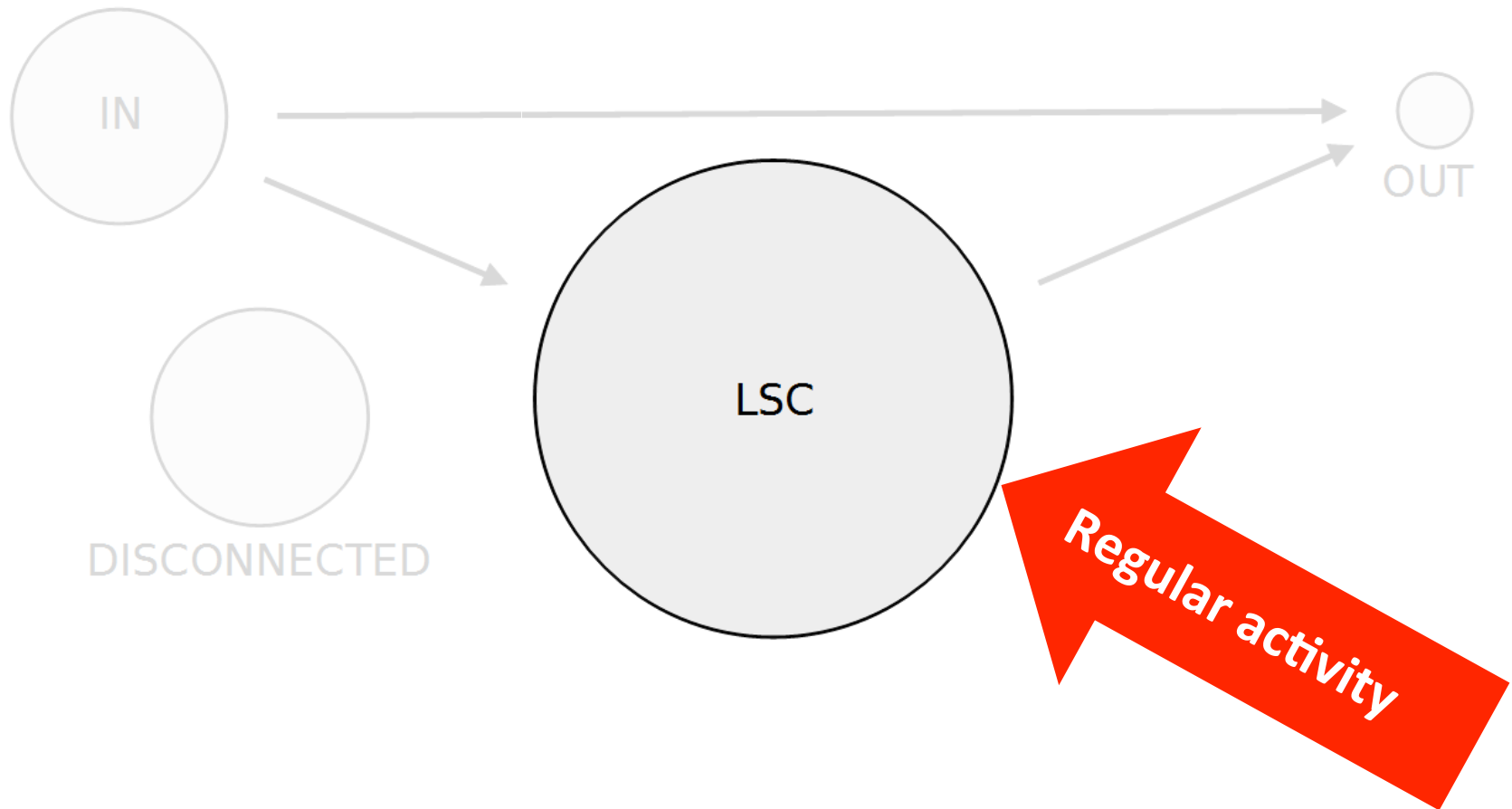

1,5% of the tweets
5,3% of the accounts
0% outgoing edges

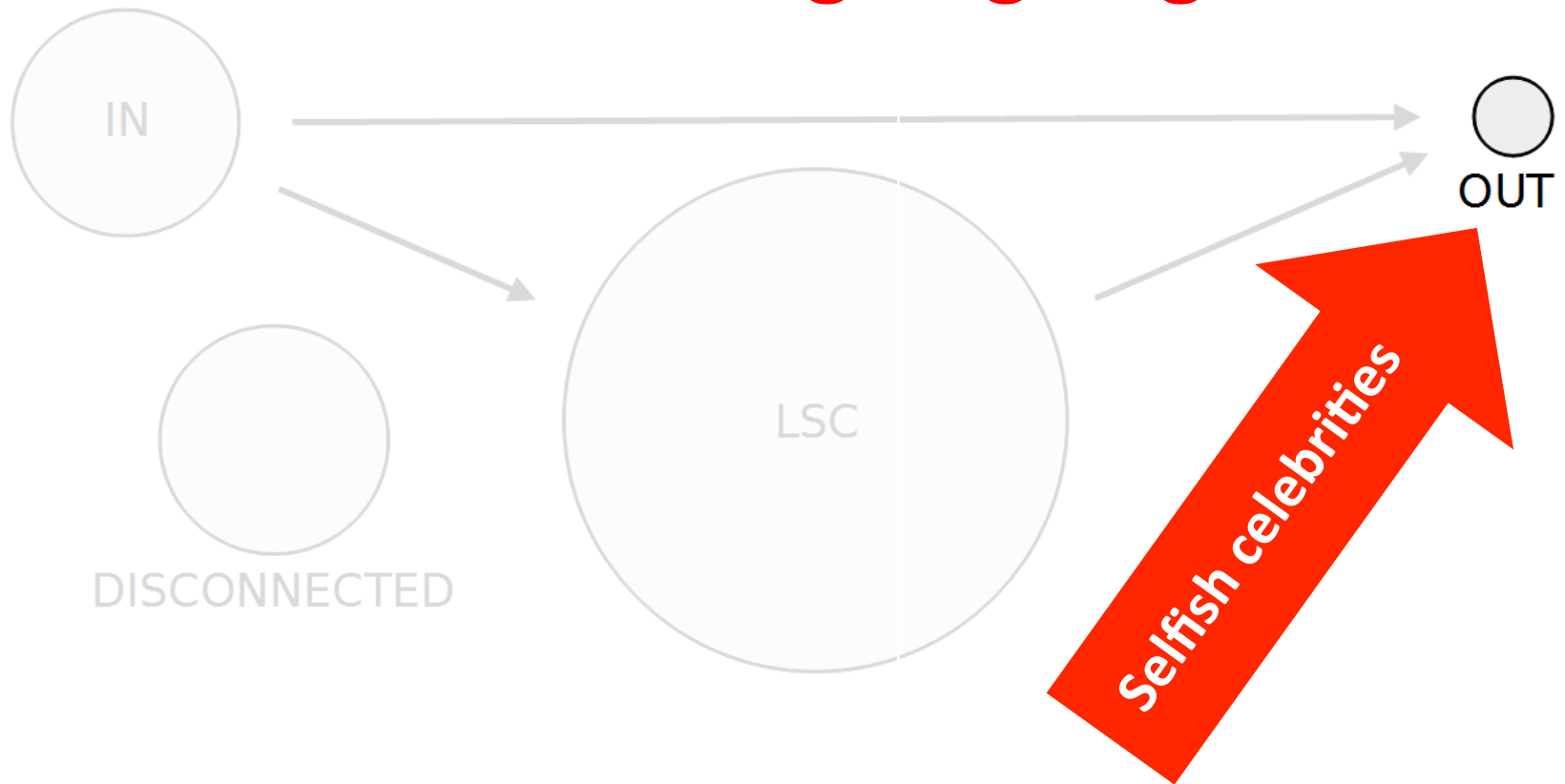

21,4% of the accounts
0,25% of the tweets



21,6% of the accounts

99% no edge

80% no tweet

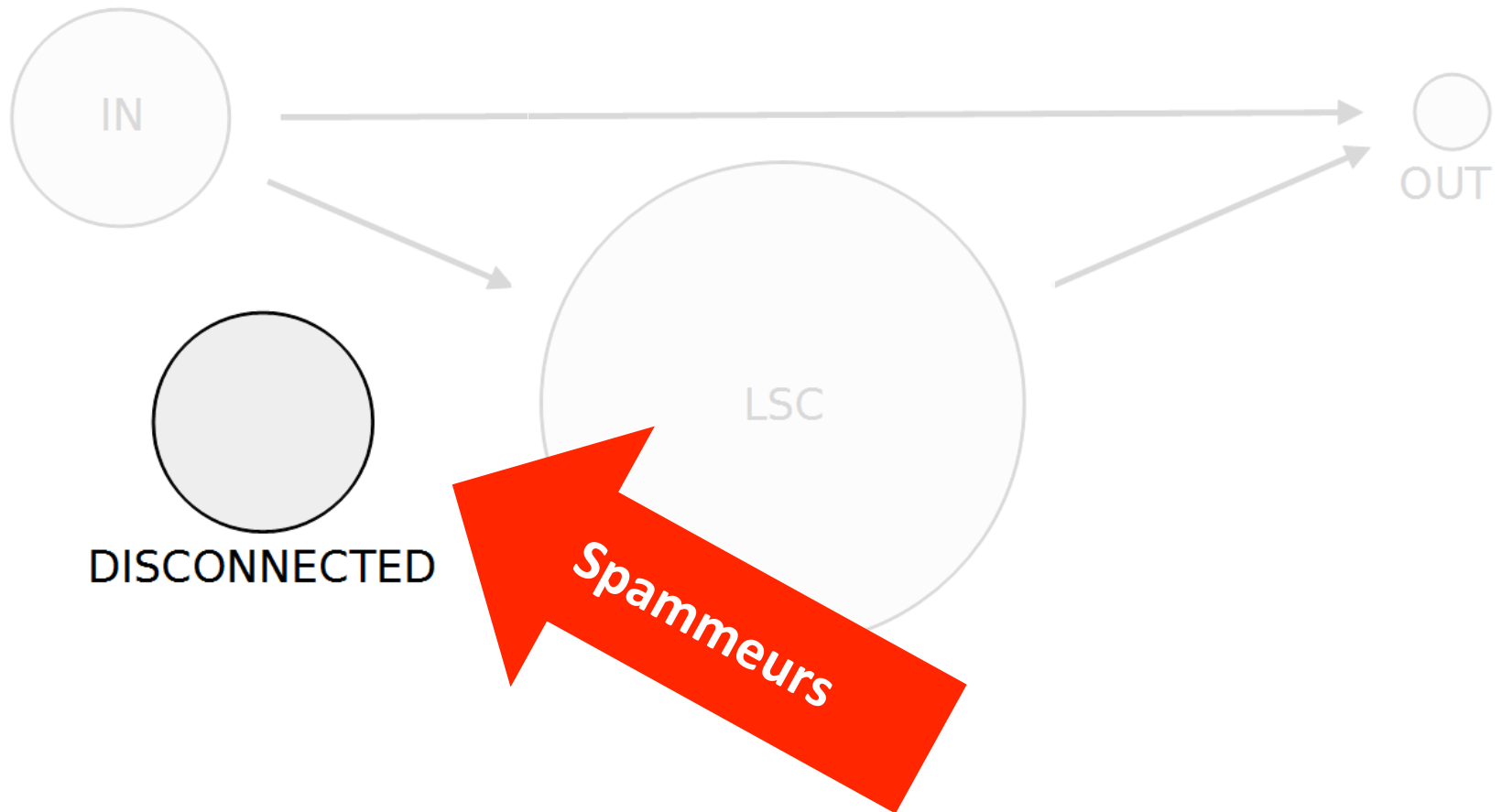

Information propagation in social networks

Maksym Gabielkov, Ashwin Rao, Arnaud Legout

EPI DIANA, Sophia Antipolis

{maksym.gabielkov, arnaud.legout}@inria.fr

□ Twitter in **2009**

- 41.7 million users
- 1.47 billion follow links
- Average degree: **35**
- **Partial** crawls

□ Twitter in **2012**

- 537 million users
- 23.95 billion follow links
- Average degree: **44**
- **Complete** crawl

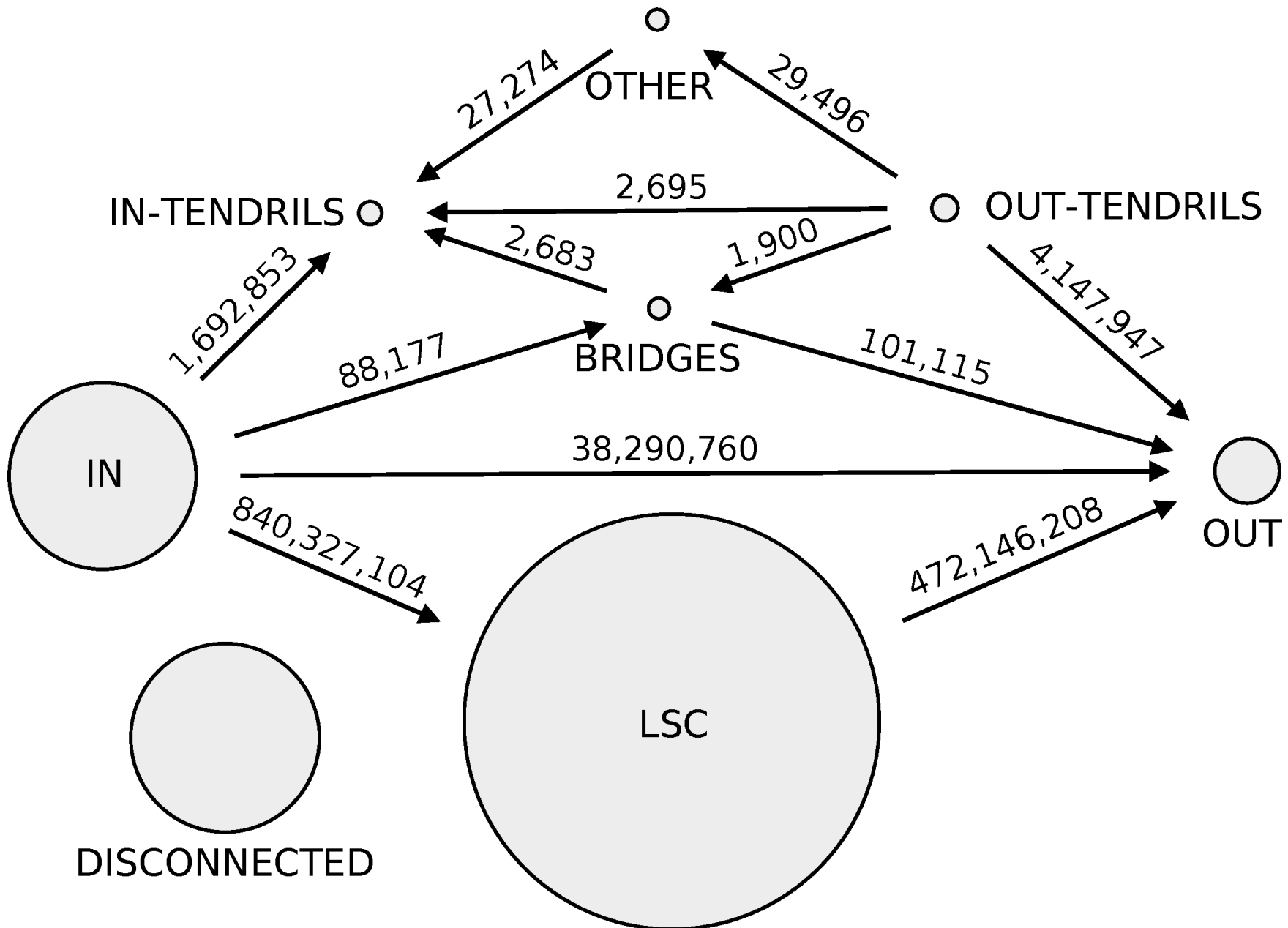

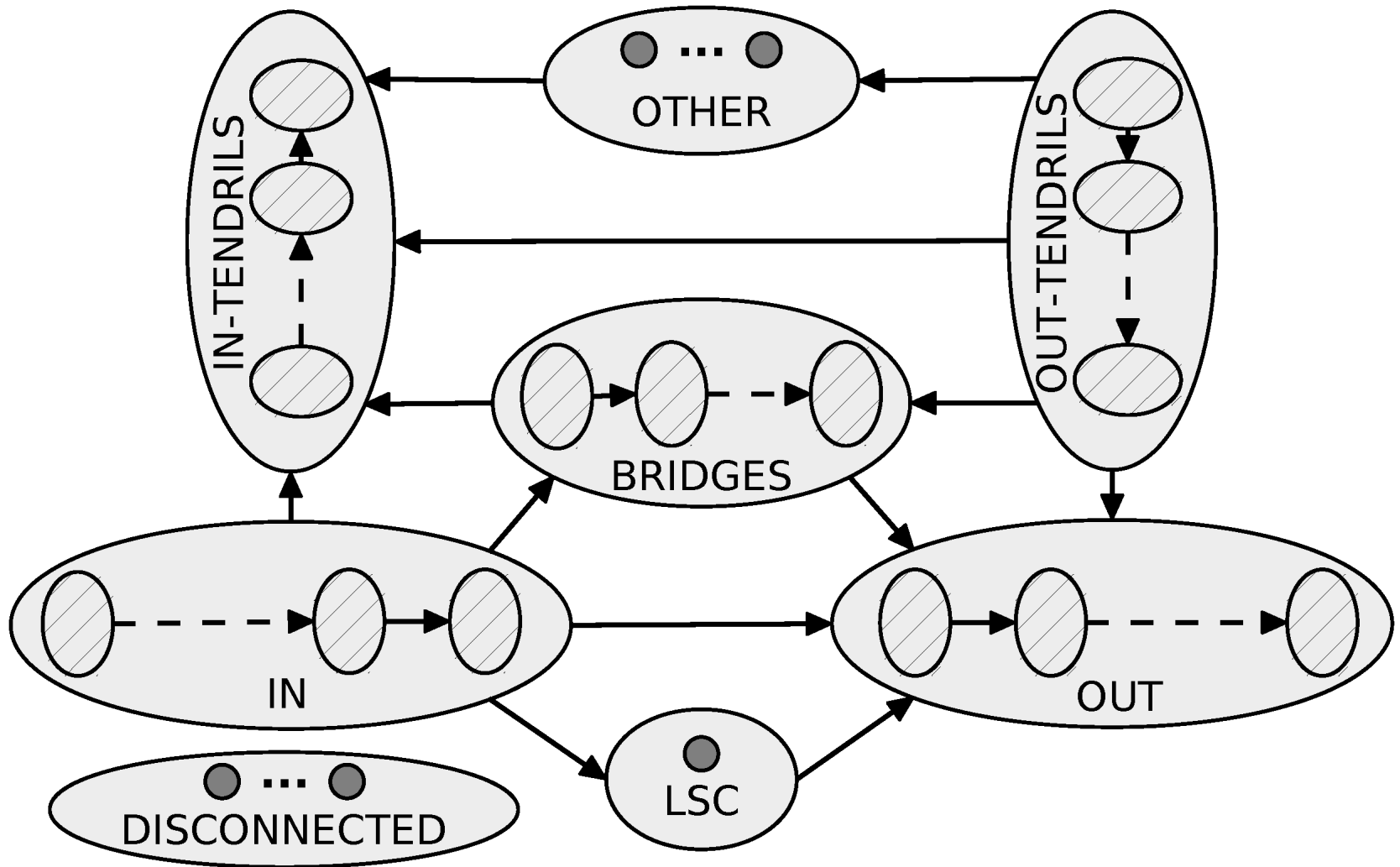

● : SCC	→ : weighted arc	▨ : level	○ : macrostructure component
---------	------------------	-----------	------------------------------